

APPROVAL - CUSTOMER NAME & SIGNATURE	DATE

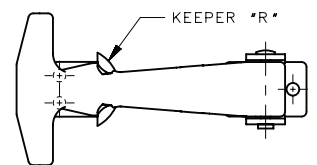

PART NUMBER 37-20-086-10 SHOWN
SCALE 1:2

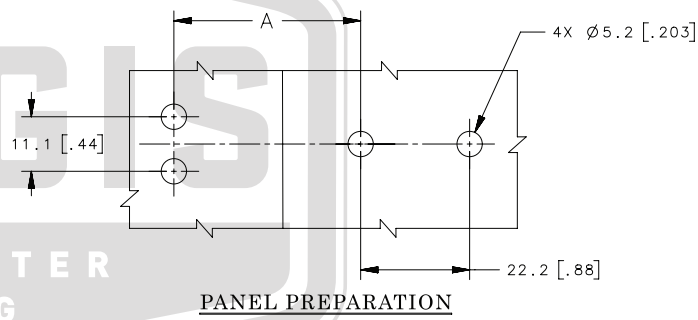
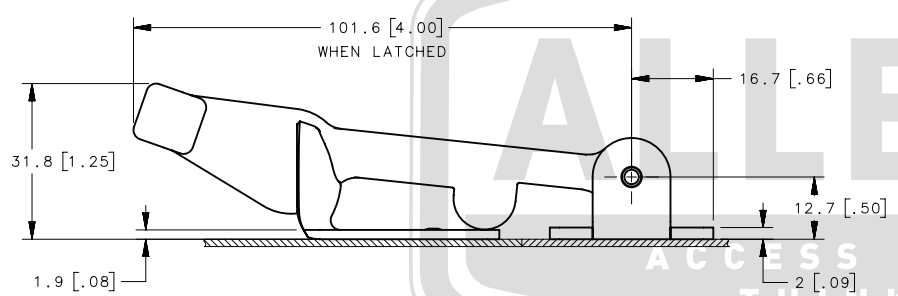
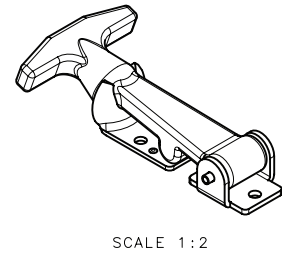
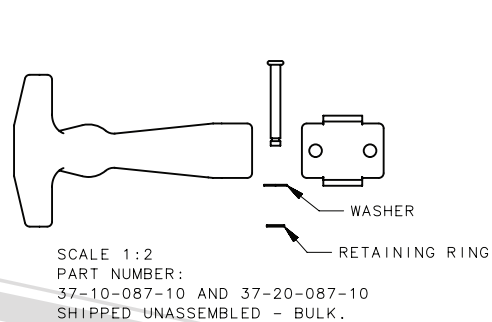
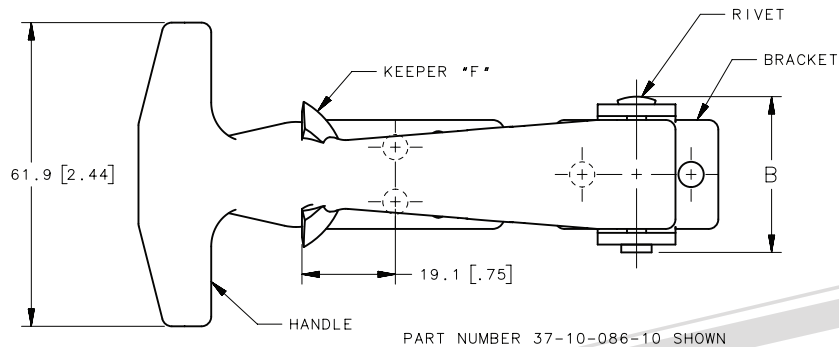
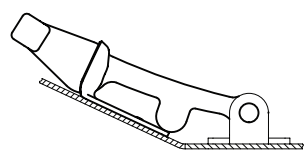

SUITABLE FOR NON-COPLANAR MOUNTING
SCALE 1:2

37-20-087-10	LATCH SHIPPED UNASSEMBLED	EPDM RUBBER, BLACK	SEE NOTE 2	SEE NOTE 2	SEE NOTE 2	R	73[2.88]	34.1[1.34]
37-10-087-10	LATCH SHIPPED UNASSEMBLED	EPDM RUBBER, BLACK	SEE NOTE 2	SEE NOTE 2	SEE NOTE 2	F	38.1[1.50]	34.1[1.34]
37-25-086-24	KEEPER	-	-	-	SEE NOTE 3	R	-	-
37-11-086-20	HANDLE SUB-HANDLE ASSEMBLY	EPDM RUBBER, BLACK	SEE NOTE 3	SEE NOTE 3	-	-	-	-
37-20-086-20	LATCH, ASSEMBLED	-	-	-	-	-	73[2.88]	31.8[1.25]
37-25-086-17	KEEPER	-	-	-	SEE NOTE 2	R	-	-
37-11-086-10	HANDLE SUB-HANDLE ASSEMBLY	EPDM RUBBER, BLACK	SEE NOTE 2	ALUMINUM, NATURAL	-	-	-	-
37-20-086-10	LATCH, ASSEMBLED	-	-	-	-	-	73[2.88]	31.8[1.25]
37-15-086-24	KEEPER	-	-	-	SEE NOTE 3	F	-	-
37-11-086-20	HANDLE SUB-HANDLE ASSEMBLY	EPDM RUBBER, BLACK	SEE NOTE 3	SEE NOTE 3	-	-	-	-
37-10-086-20	LATCH, ASSEMBLED	-	-	-	-	-	38.1[1.50]	31.8[1.25]
37-15-086-17	KEEPER	-	-	-	SEE NOTE 2	F	-	-
37-11-086-10	HANDLE SUB-HANDLE ASSEMBLY	EPDM RUBBER, BLACK	SEE NOTE 2	ALUMINUM, NATURAL	-	-	-	-
37-10-086-10	LATCH, ASSEMBLED	-	-	-	-	-	38.1[1.50]	31.8[1.25]
PART NUMBER	TYPE OF COMPONENT	HANDLE	BRACKET MATERIAL, FINISH	RIVET/STUD	KEEPER	KEEPER TYPE	A	B

- NOTES:
- LATCH PACKAGED ONE HANDLE SUB-ASSEMBLY AND ONE KEEPER PER BAG.
FOR BULK PACKAGING: ORDER HANDLE SUB-ASSEMBLY AND KEEPER PART NUMBERS SEPARATELY.
 - STEEL, ZINC PLATE, BRIGHT CHROMATE PLUS SEALER.
 - STAINLESS STEEL, PASSIVATED.

ALLEGIS	1-866-378-7550
MATERIAL: Rubber & Steel	DRAWING NO. : 37-10-086-10
FINISH: Zinc Plate, bright chromate	
REV. : 1:1	DATE: 5/28/2019